

MagConnect™ or VESA HD Dashboard Mount

JOY
thejoyfactory

Compatible with
VESA 75x75mm
100x50mm and
100x100mm
configurations
(hardware is not
included)

38mm or 26mm
VESA Ball Joint

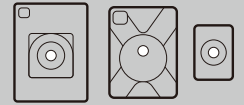
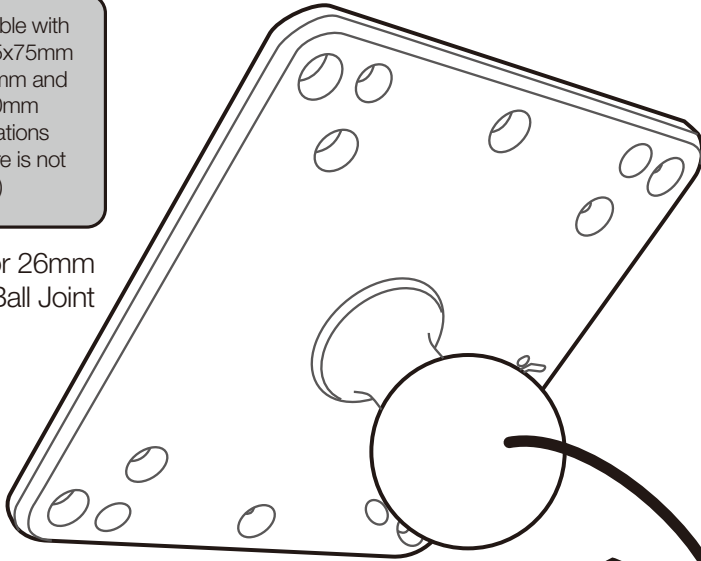

MagConnect Cases &
Module Compatible
(Not Included)

38mm or 26mm
MagConnect Ball Joint

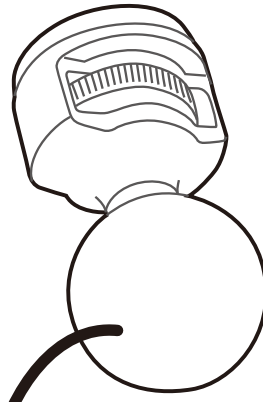

⚠ Always release the
bracket to adjust parts

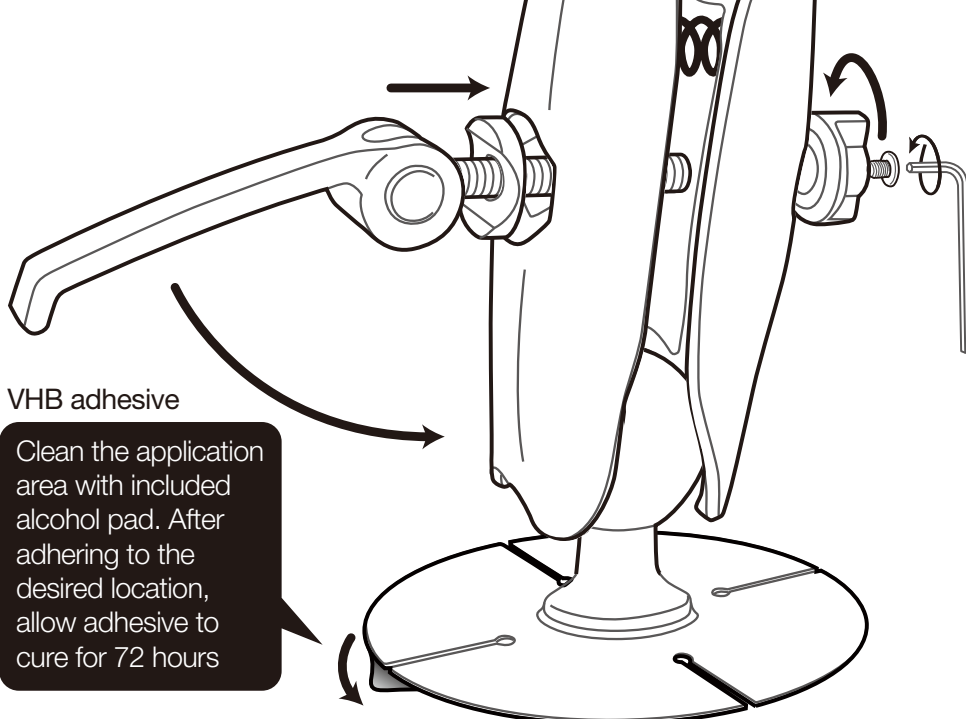

VHB adhesive

Clean the application
area with included
alcohol pad. After
adhering to the
desired location,
allow adhesive to
cure for 72 hours

Content List

1

MagConnect or VESA
Ball Joint

MagConnect SKU#:
MMU331 (38mm)
MMU231 (26mm)

VESA SKU#:
MVU331 (38mm)
MVU231 (26mm)

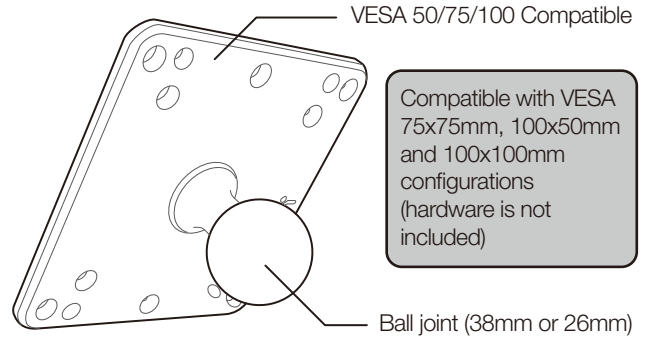
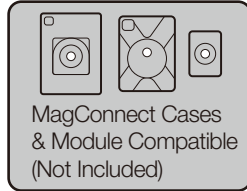
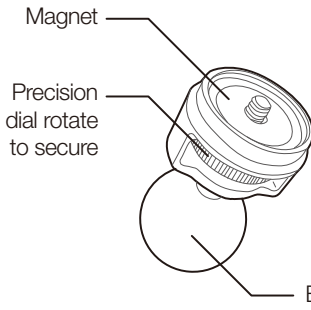

2

Mount Arm

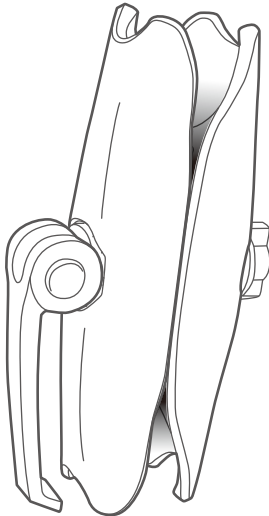

3

Dashboard Mount Base

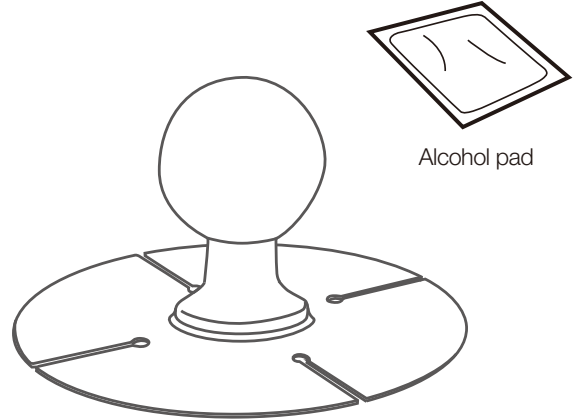

Base Installation

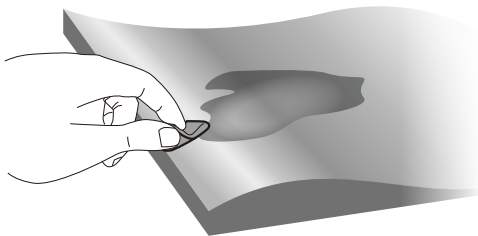

Clean the surface area with the included alcohol pad

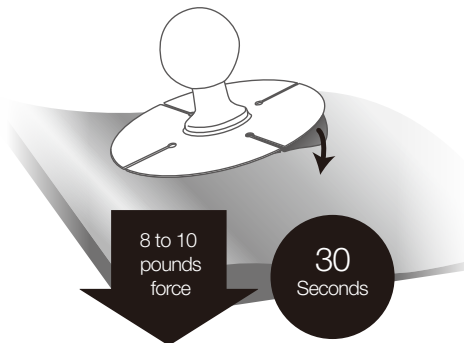

Affix base to surface being sure to apply at least 10 pounds of force for 30 seconds

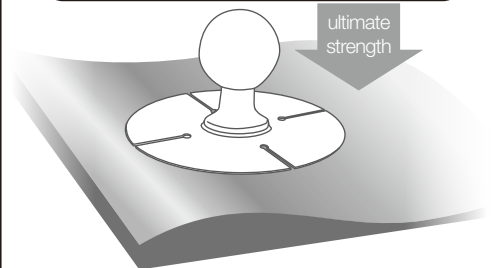
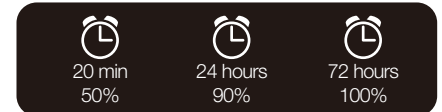

After adhering, allow adhesive to cure for 72 hours for 100% strength

Arm Installation

1 Assemble spring and lever

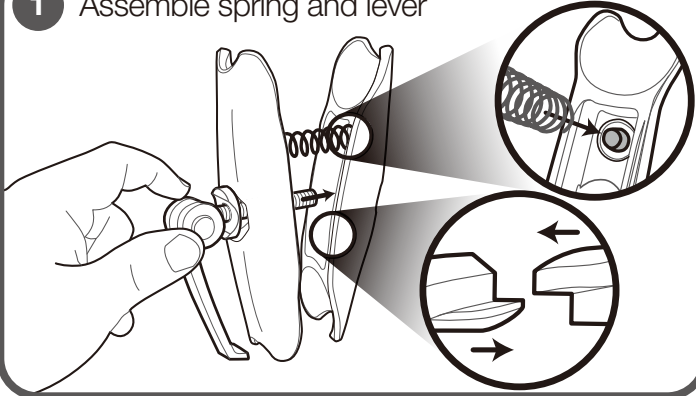

2 Thread on cap clockwise, do not fully insert

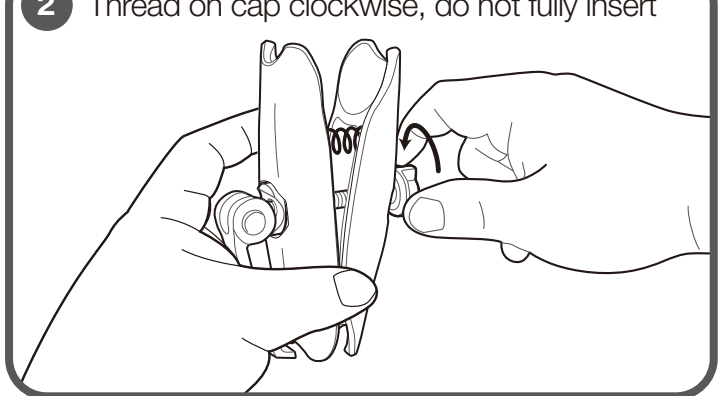

3 Insert base ball joint into arm

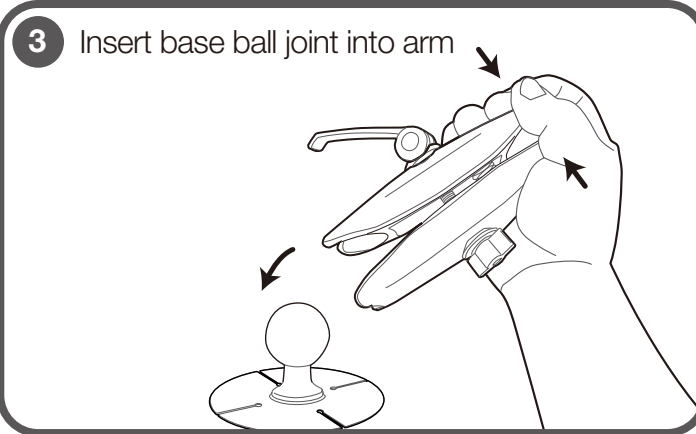

4 Insert the MagConnect / VESA ball joint

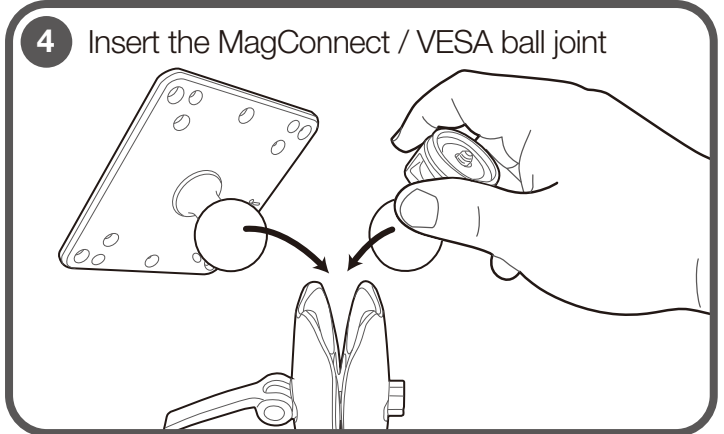

5 Turn lever clockwise until hand-tight



6 Push lever down



7 Insert screw into the end cap and fully tighten down

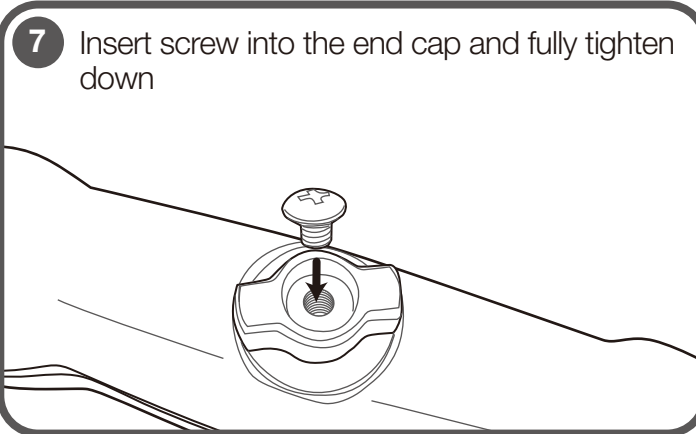

DISCLAIMER FOR JOY FACTORY TABLET MOUNTS

Congratulations on the purchase of your new Tablet Mount from The Joy Factory, Inc!

BEFORE YOU INSTALL OR USE YOUR TABLET MOUNT, PLEASE READ ALL LITERATURE PROVIDED WITH YOUR MOUNT TO ENSURE THE MOUNT YOU PURCHASED IS COMPATIBLE WITH THE TABLET OR TABLETS YOU INTEND TO USE WITH THE MOUNT. IF YOU ARE NOT CERTAIN WHETHER THE MOUNT IS COMPATIBLE WITH YOUR TABLET(S), PLEASE CHECK THE JOY FACTORY WEBSITE OR CONTACT CUSTOMER SERVICE.

BEFORE YOU INSTALL OR USE YOUR TABLET MOUNT, READ THIS DOCUMENT AND ALL INSTRUCTIONS CAREFULLY. IMPROPER USE OF THE MOUNT WILL RESULT IN DAMAGE TO YOUR TABLET. USE OF THE MOUNT WITH OTHER DEVICES MAY CREATE AN INSECURE MOUNTING OF THE DEVICE, MAY PLACE UNANTICIPATED LOADS OR STRESS ON THE MOUNT, AND/OR WEAKEN THE MOUNT.

USE OF YOUR TABLET MOUNT WITH DEVICES OTHER THAN THOSE DEVICES FOR WHICH IT IS DESIGNED WILL VOID ALL WARRANTIES FROM THE JOY FACTORY, WHETHER SUCH WARRANTIES ARE EXPRESS OR IMPLIED. THE JOY FACTORY DISCLAIMS ANY AND ALL LIABILITY FOR USE OF OUR MOUNTS WHEN IT IS NOT USED AS DESIGNED OR WHEN IT IS USED FOR ANY PURPOSE OTHER THAN THE PURPOSE FOR WHICH IT IS DESIGNED.

THE JOY FACTORY SELLS VARIOUS MOUNTS FOR DIFFERENT USES OR APPLICATIONS. ONLY USE YOUR Tablet MOUNT FOR ITS INTENDED PURPOSE AND ONLY WHEN AND WHERE IT IS SAFE TO DO SO AND ONLY WHERE PERMITTED BY LAW.

The Joy Factory's Tablet mounts are not intended to protect the electronics used with the mounts from damage to, or loss or theft of, the Tablets. All liability for damages or loss or theft of an electronic device used in conjunction with The Joy Factory mounts is disclaimed and all warranties relating to same, whether express or implied, are also disclaimed by The Joy Factory.

Installation or attachment of any mounts from The Joy Factory must be done in conjunction with the instructions provided by The Joy Factory, and liability for damage to the mounts or anything to which they are attached, and any warranties, whether express or implied, are disclaimed by The Joy Factory.

For Mounts Used in Motor Vehicles:

FOR MOUNTS USED IN MOTOR VEHICLES, NEVER USE OUR MOUNTING DEVICE OR ELECTRONICS WHILE OPERATING THE VEHICLE OR WHILE THE VEHICLE IS IN MOTION.

The Joy Factory disclaims any liability and all warranties, whether express or implied, for use of its mounts in motor vehicles in any way which is not allowed by law. The Joy Factory disclaims any liability and all warranties, whether express or implied, for use of its mounts in any way which interferes with the ability of the driver to operate the motor vehicle, distracts the driver of the motor vehicle, or is otherwise dangerous or reckless. The Joy Factory will not pay for damages incurred or for citations, tickets, or fines issued due to improper mounting or use of its mounts.

For mounts used in vehicles, passengers in the vehicle should only use our mounting device or electronic devices when it is safe to do so and only where such use does not distract the operator of the vehicle or distract the operator's ability to safely operate the vehicle.

With respect to The Joy Factory mounts designed to mount to a vehicle windshield via suction cup, it is critical to confirm whether such mounts are legal in your state and, if so, any limitations on use of suction cup attachments to windshields. Some states completely ban use of suction cup mounts to windshields in motor vehicles. Some other states may allow use of suction cup mounts to a vehicle's windshield, but only in certain locations on the windshield or in a manner which does not obstruct the driver's vision or otherwise distract the driver of the motor vehicle.

With respect to The Joy Factory mounts designed to mount to a vehicle's seats using bolts, you are encouraged to hire a professional to install that mount. Installation of bolt-mounted devices from The Joy Factory must be done pursuant to instructions from The Joy Factory and from the manufacturer of your vehicle. Improper installation of a mounted device bolted to your vehicle's seat may lead to the mount and/or the vehicle's seat or other parts of the vehicle, being incapable of operating as intended. Any and all damages to your vehicle, the mount or any electronic device due to improper installation, whether by you, a professional, or any other third party, is not the responsibility of The Joy Factory, and The Joy Factory disclaims any and all such warranties, whether express or implied, for improper installation or use of bolt mounted devices.

The Joy Factory will replace your Tablet mount if it has any manufacturing defects, free of charge, for one year from the date of purchase. If you believe the mount has a manufacturing defect, cease use immediately and contact The Joy Factory by email at support@thejoyfactory.com or by telephone at (949) 216-8888, Monday through Friday, 9:00 a.m. to 5:00 p.m., Pacific Time. Unfortunately, The Joy Factory is not able to replace or pay for replacement of Tablets or any additional items which may be damaged from use of a mount from The Joy Factory, whether the mount has or does not have manufacturing defects.

If your mount is damaged for any reason, or is not functioning properly for any reason, immediately stop using it. The Joy Factory expressly disclaims all liability and all warranties, whether express or implied, for use of one of its mounts that has been damaged for any reason. The Joy Factory will not replace a mount that is damaged, other than a mount with a manufacturing defect, nor will it replace, or pay for replacement of Tablets or any additional items which may be damaged due to use of a damaged or altered mount.

The Joy Factory disclaims all liability for lost or stolen mounts and any device used with said mount.

Do not use your mount from The Joy Factory with any other Tablet case. Use of an additional case may create an insecure mounting of the device, may place unanticipated loads or stress on the mount and/or may weaken the mount, and The Joy Factory disclaims all liability from such use and will void any and all warranties, express or implied.

Any alteration to your mount, or any part thereof, will void any and all warranties and guarantees, whether express or implied, and The Joy Factory disclaims any and all liability for damages arising from use of an altered mount.

For full warranty information please visit thejoyfactory.com/warranty-information.

Contact us: support@thejoyfactory.com
(949) 216-8888
Monday through Friday,
9:00 a.m. to 5:00 p.m. (PST)